

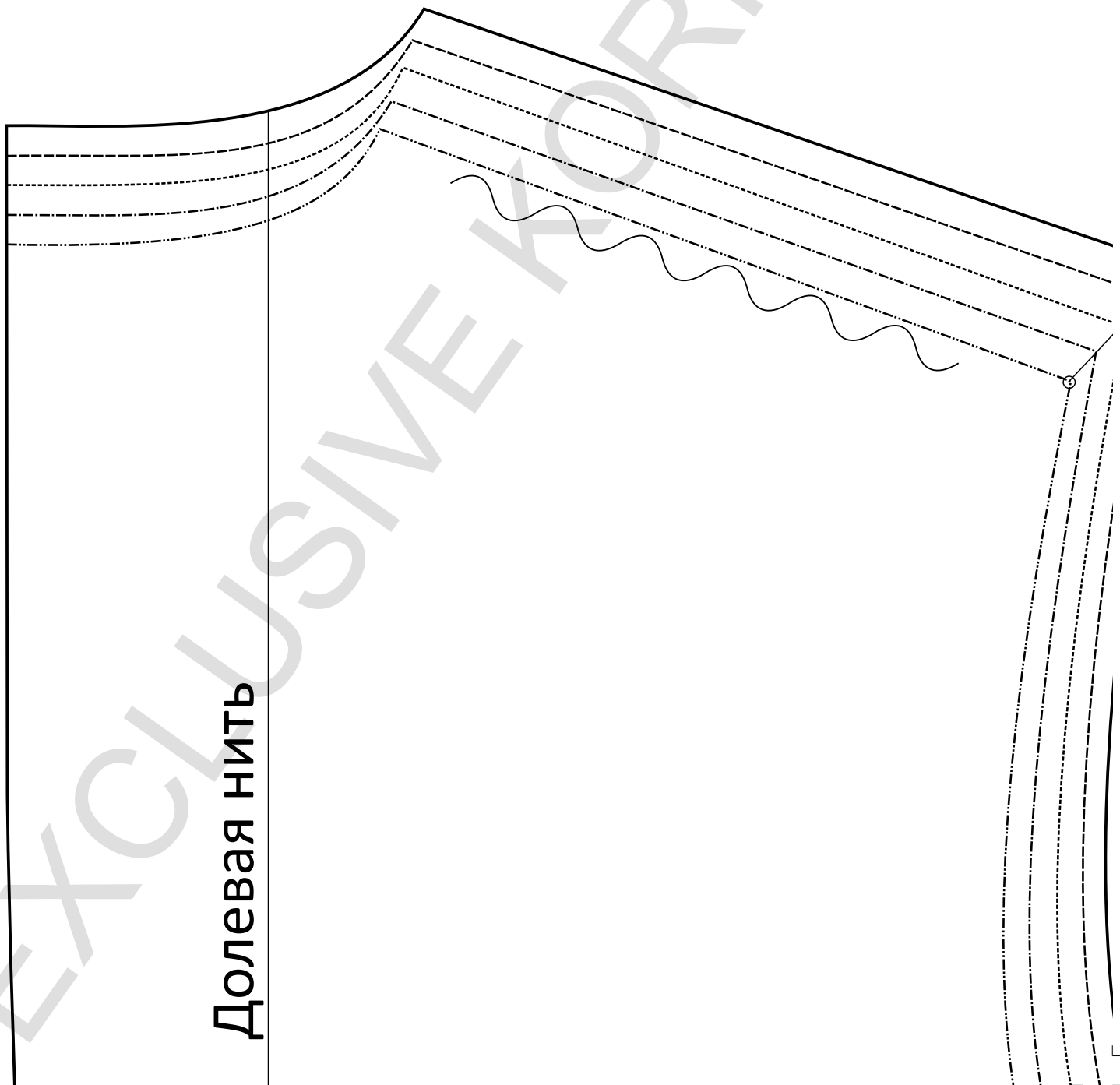

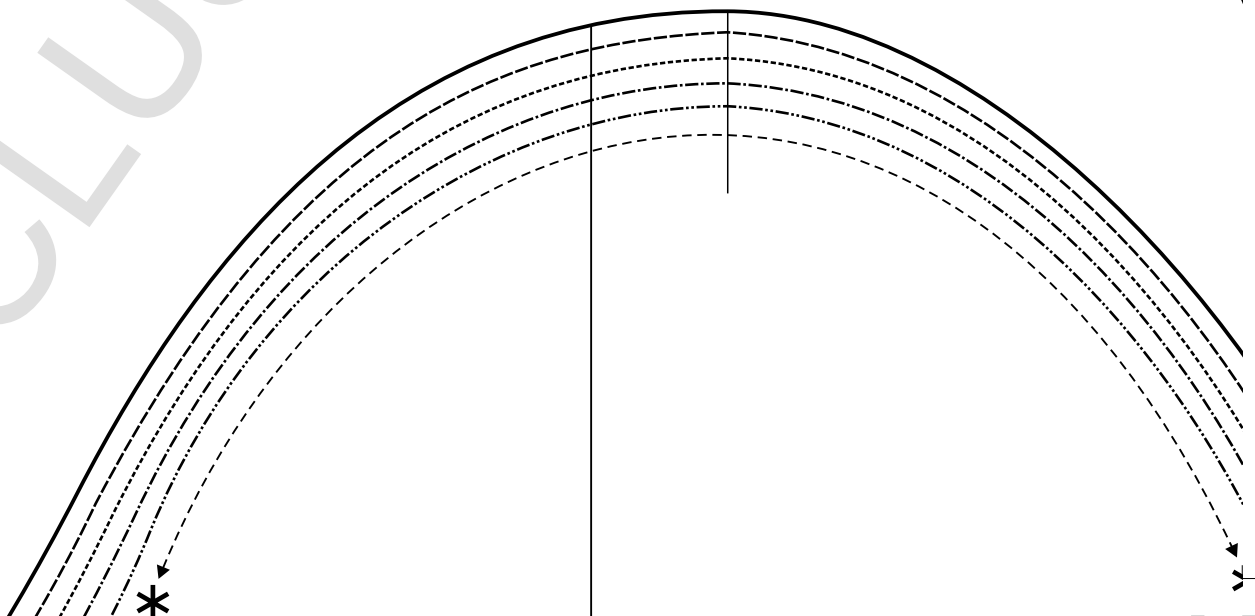

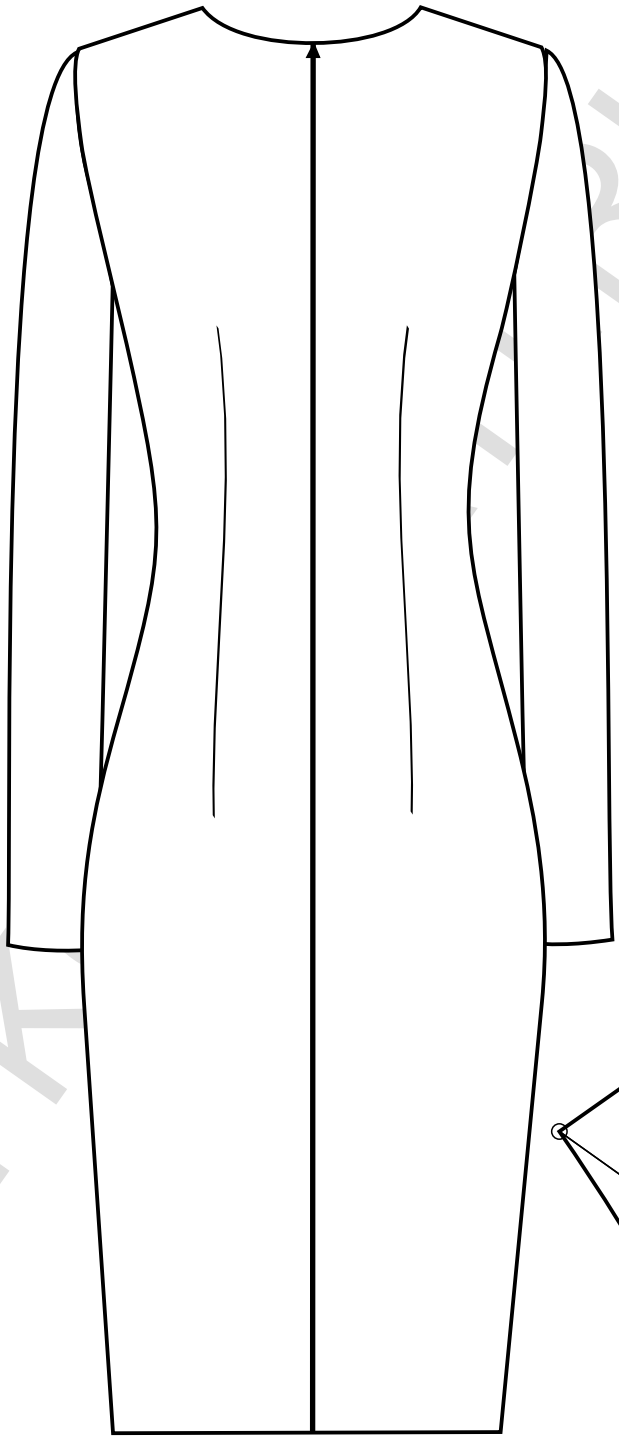
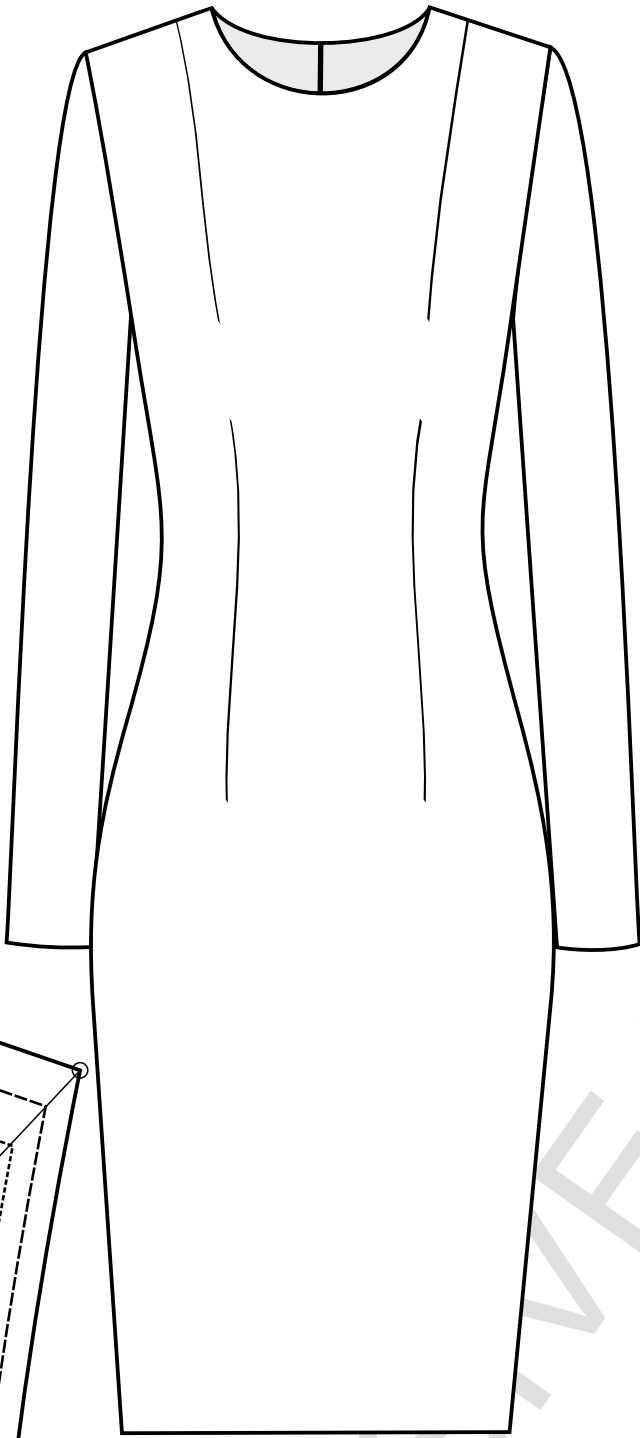

# ЛИСТ ВЫКРОЕК А

Базовая выкройка платья прилегающего силуэта и рукава на 5 размеров







- Размер 42 
- Размер 44 
- Размер 46 
- Размер 48 
- Размер 50 

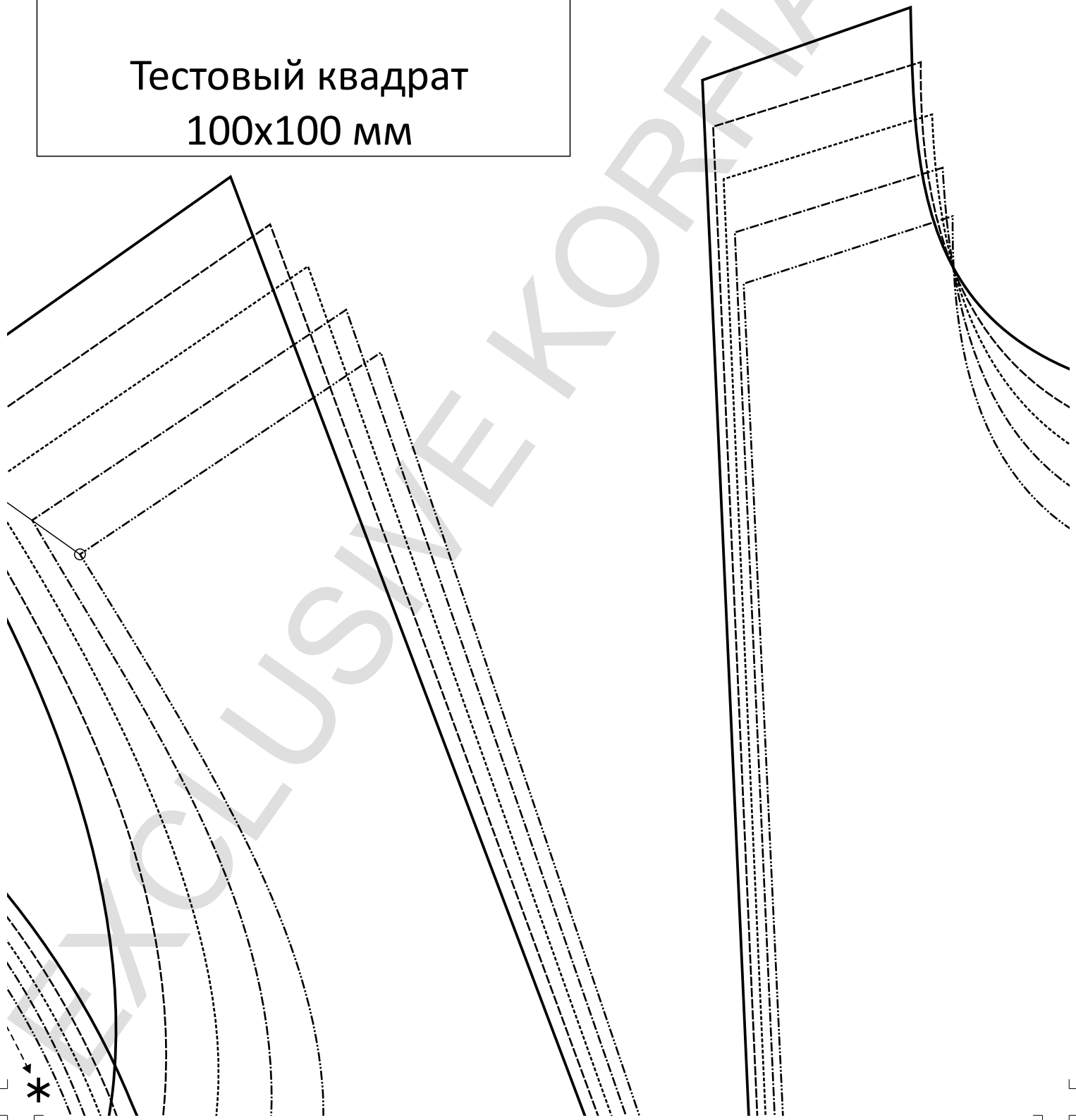

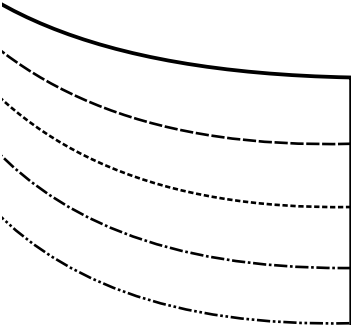
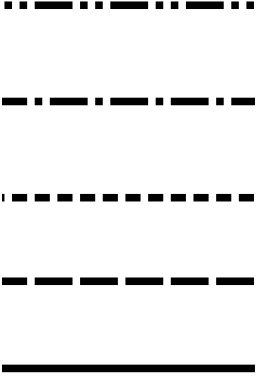

EXCLUSIVE KORFEIATI.RU

Линия проймы

Середина спинки, шов

42 50

Линия талии

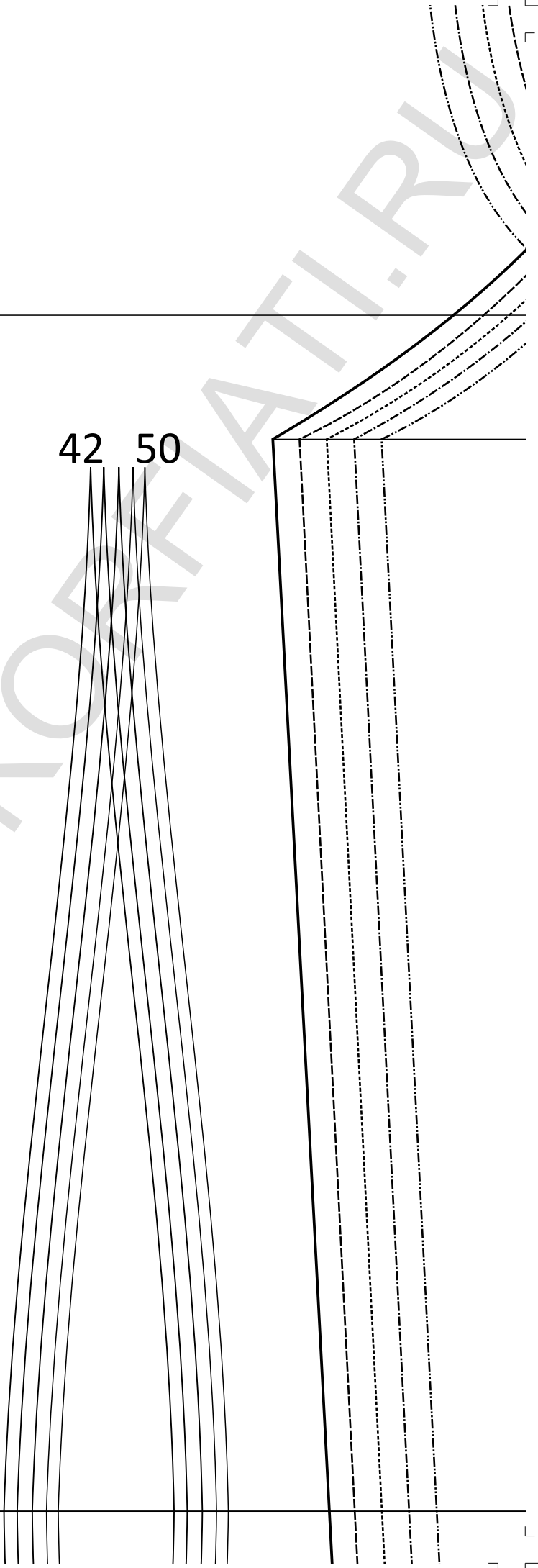

(2.2)

\*

Долевая нить

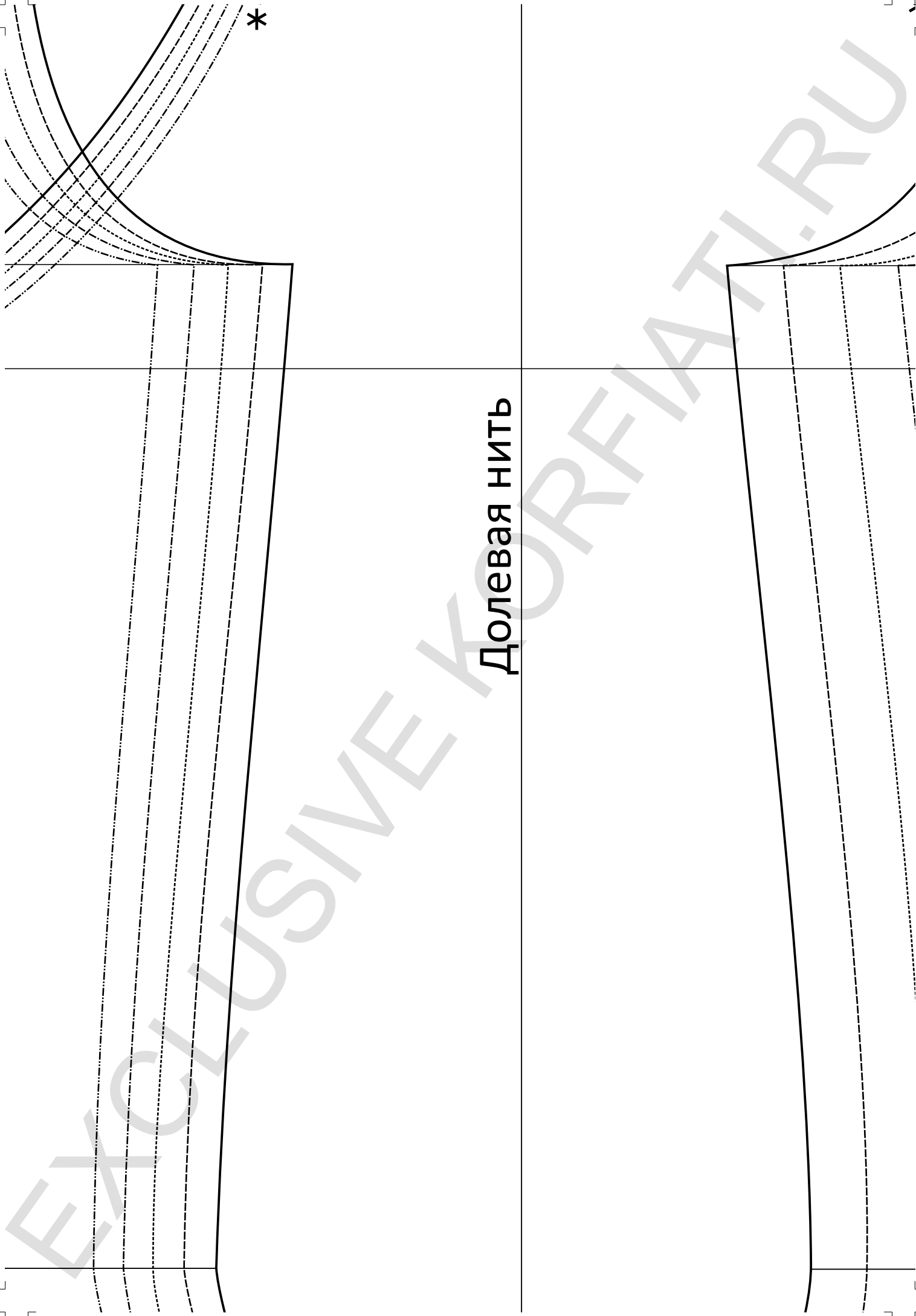

(3, 2)

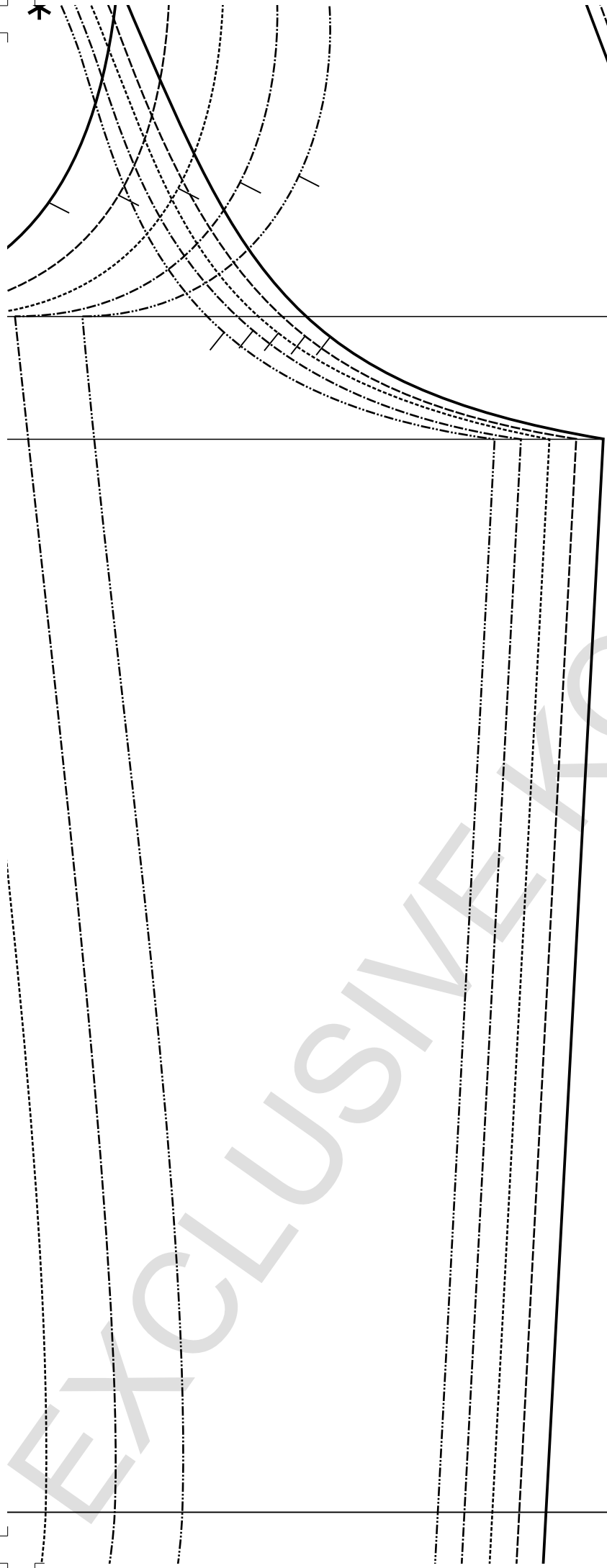

Линия г

Ц. Г.

50 42

Линия

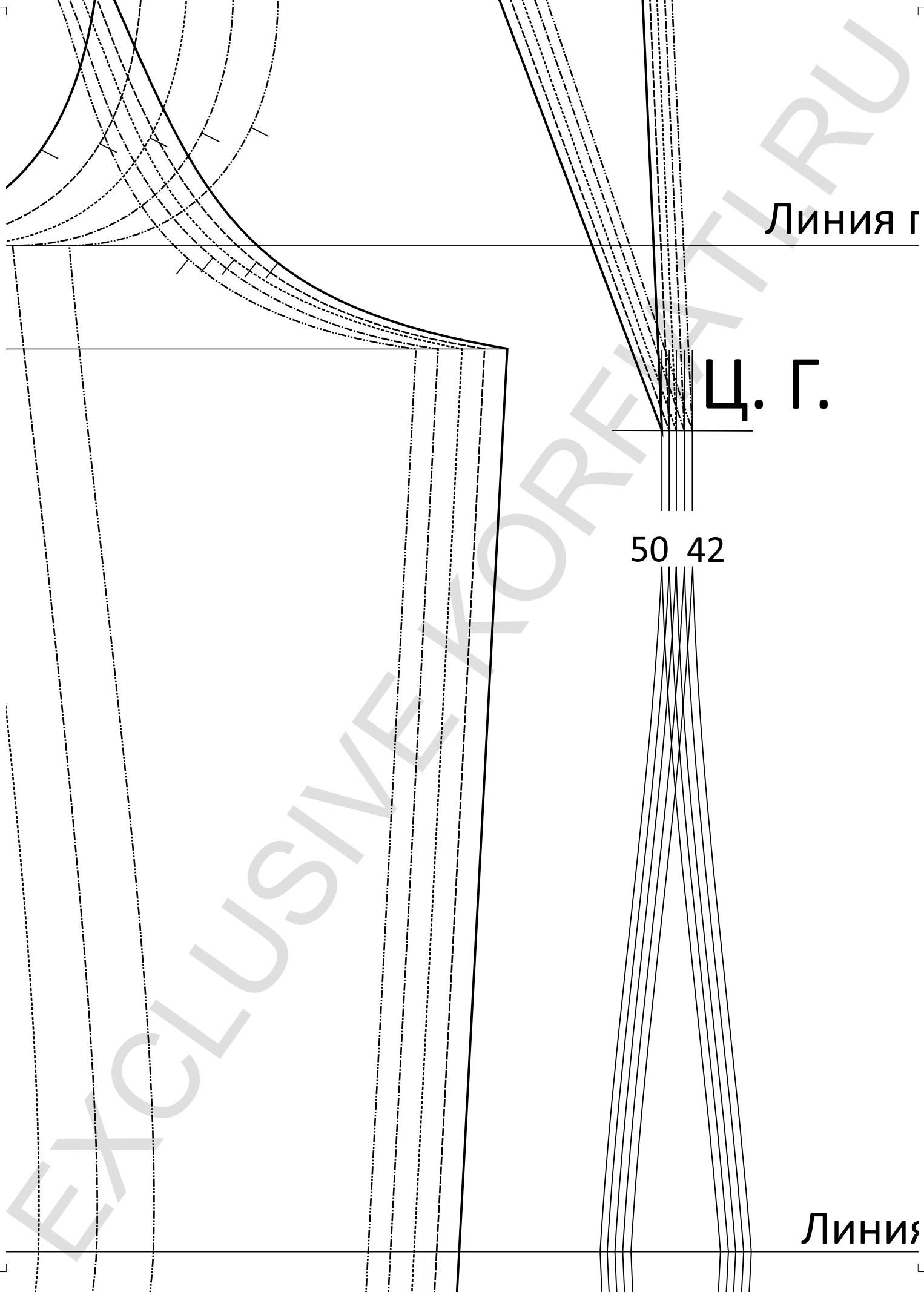

проймы

Середина переда, долевая нить

1я талии





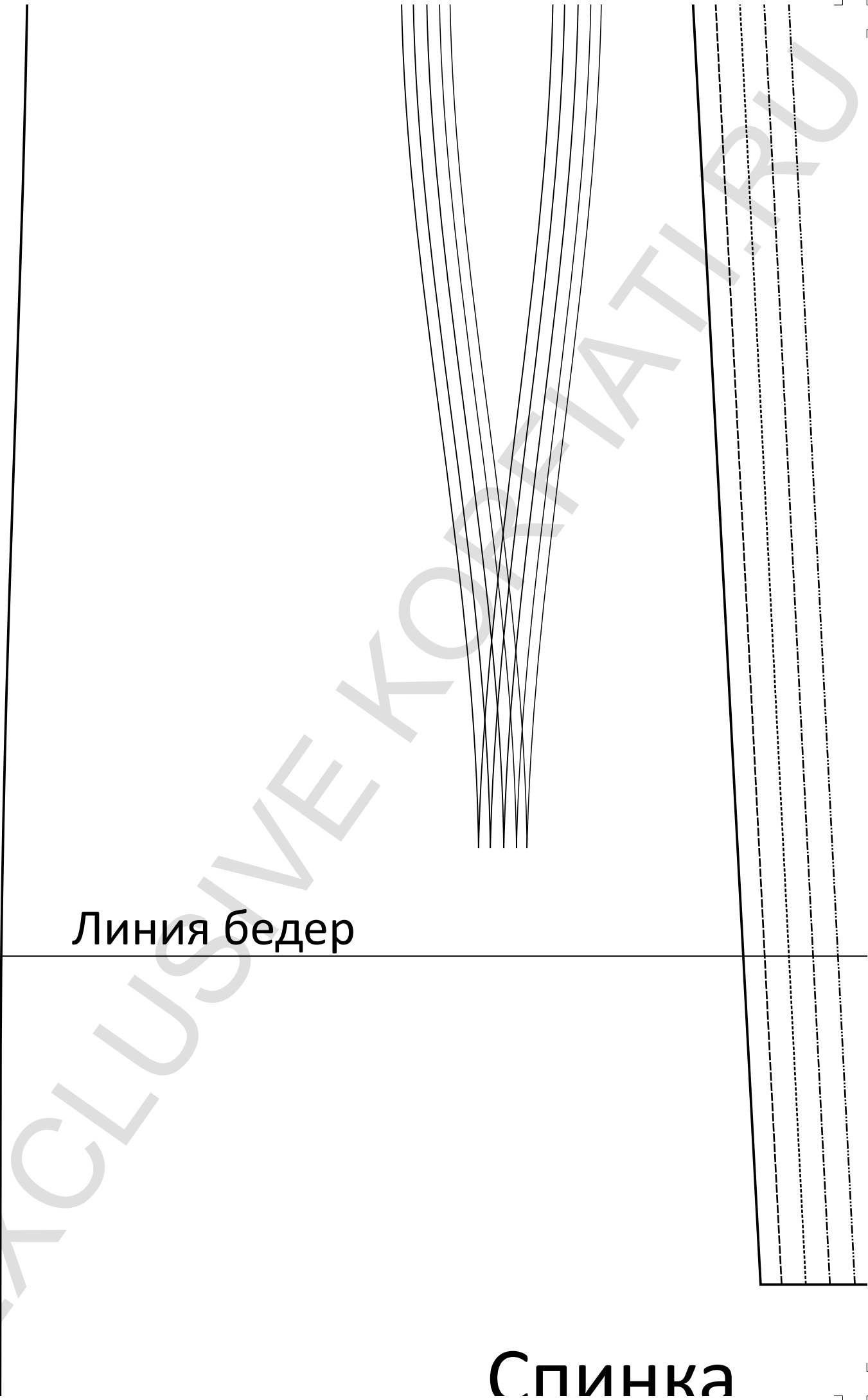

Линия бедер

Спинка



**Рукав**  
**р. 42-50**

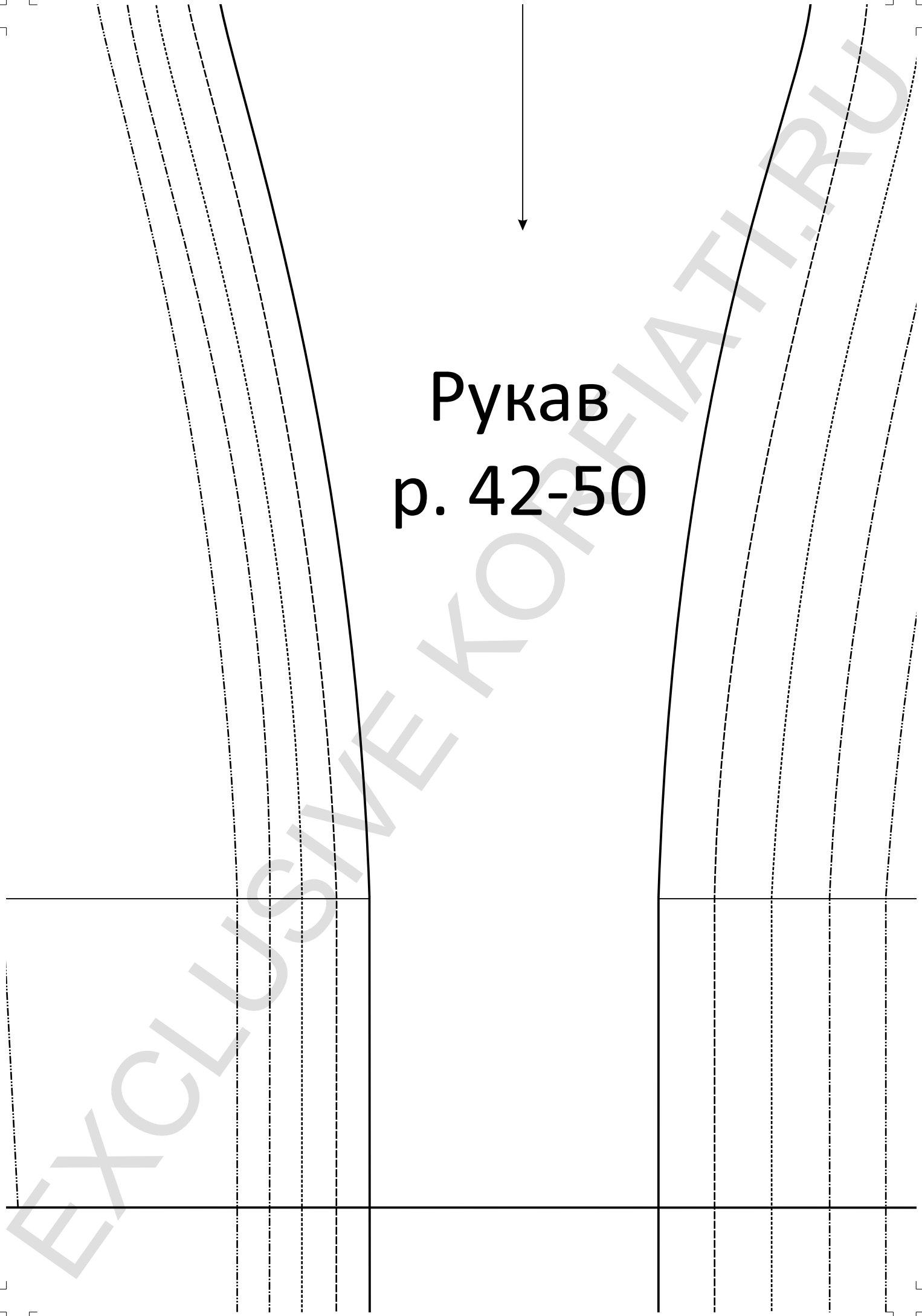

(3, 3)

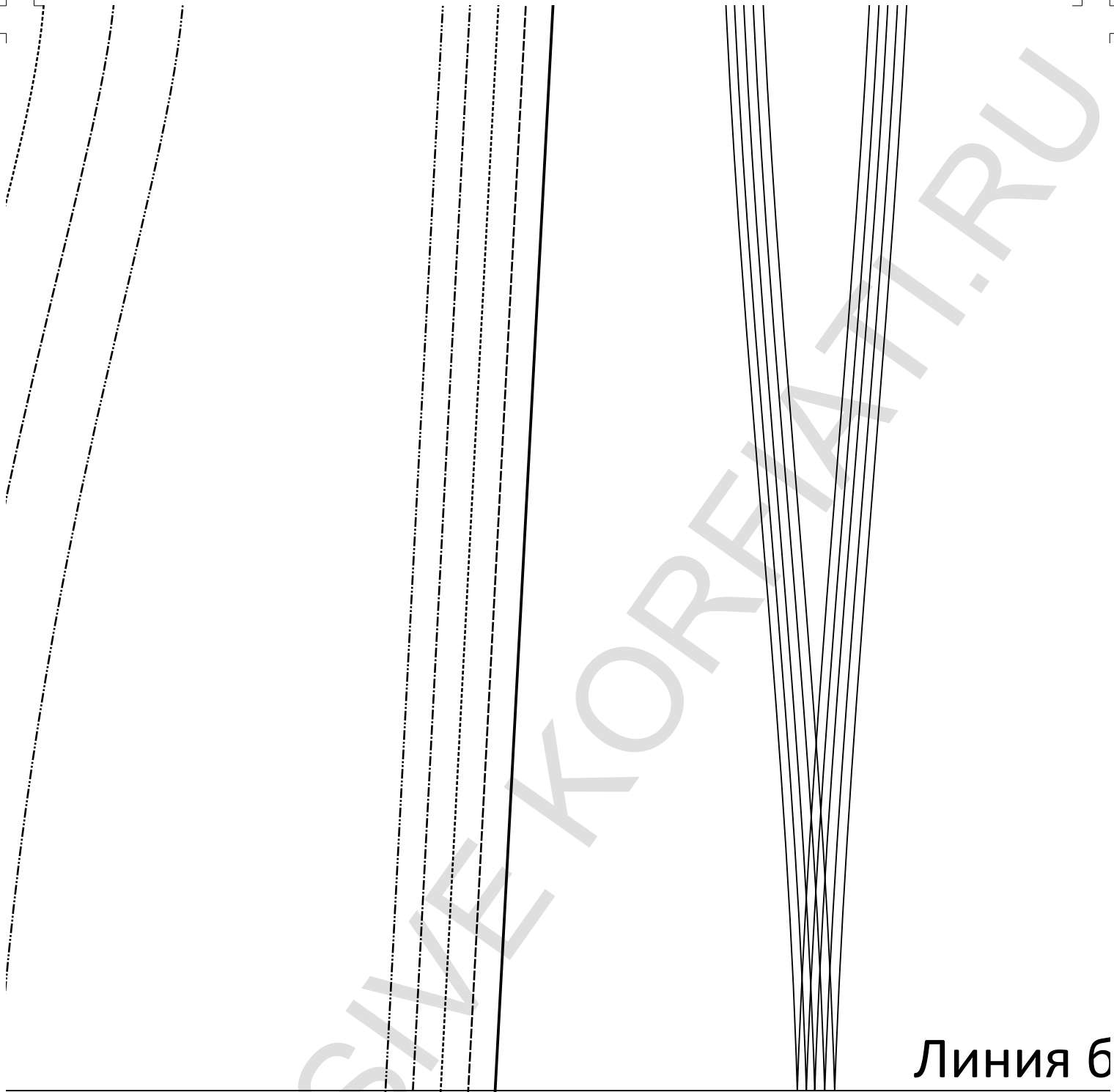

Перел

бедер

EXCLUSIVE KORFEIATI.RU

СПИНКА

р. 42-50

EXCLUSIVE KOREFATI.RU

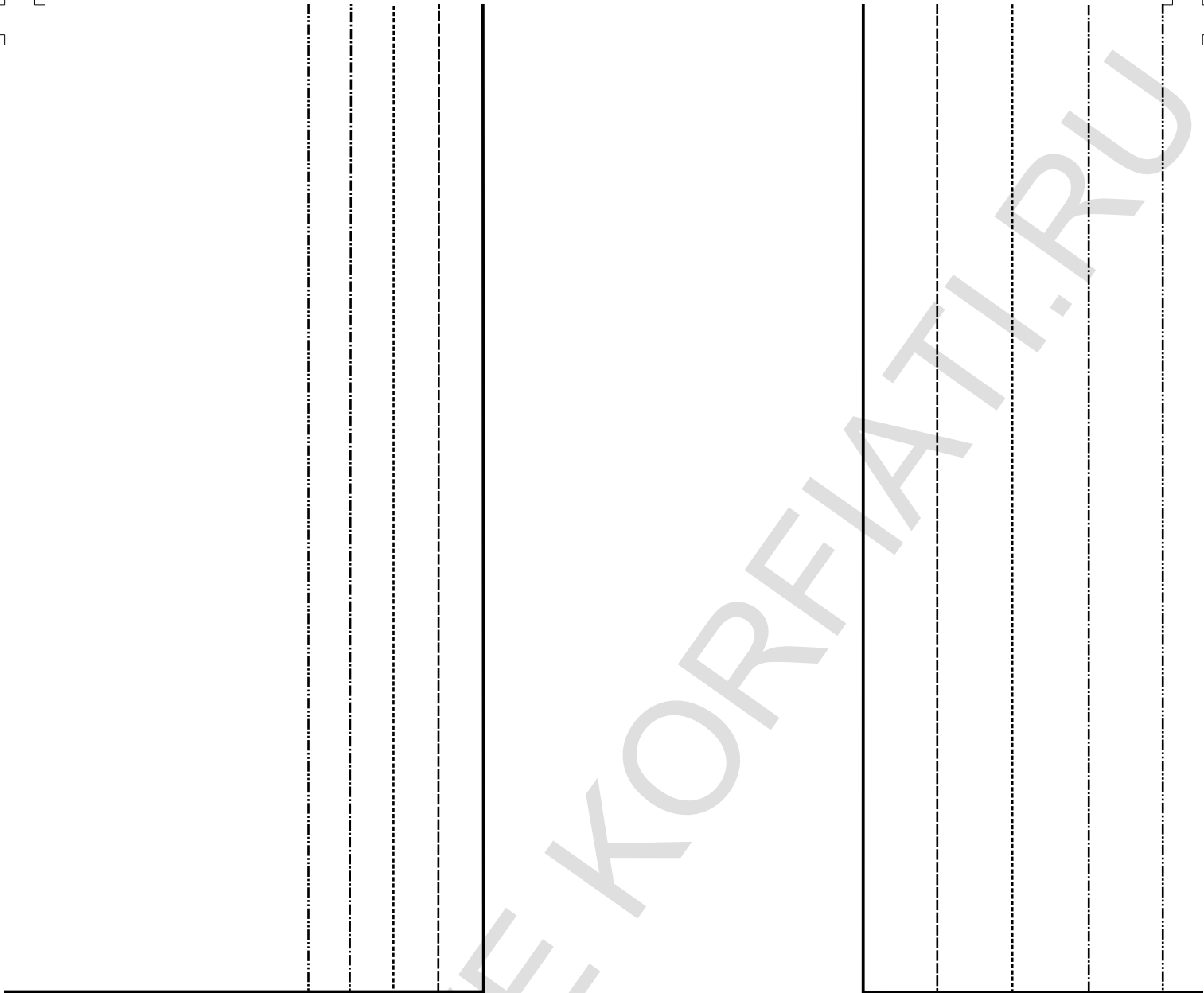

EXCLUSIVE KOREFATI.RU

# Г е р е д

## р. 42-50

EXCLUSIVE KOREFIATI.RU

---

---

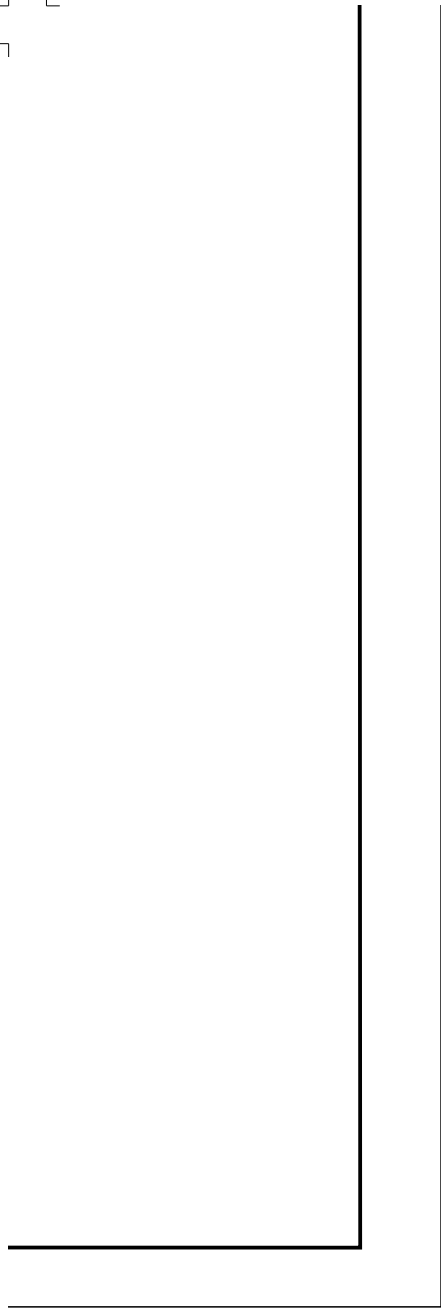

EXCLUSIVE KORFIATI.RU